

A modern wardrobe with three sliding doors made of frosted glass. The central door is open, revealing a white coat hanging on a hanger, a dark box, and folded blue and white items on shelves. To the right, a tall, multi-tiered, metallic vase stands next to a dark armchair with a stack of books on a low wooden table. The floor is light-colored wood, and a brown rug is partially visible.

Wickes

Let's do it right

Sliding Wardrobe Doors

Designs and storage solutions to suit any home

Sliding doors

Sliding doors can completely transform any room creating stunning, practical wardrobes, organising your space entirely around you. We have a large selection of sliding door designs to choose from. Choose from our pre-designed range or create your own look. We have fixed sized doors as well as custom sized options available

Why choose sliding doors

Space saving

Sliding doors not only save you space on the outside of the wardrobe, but create more on the inside!

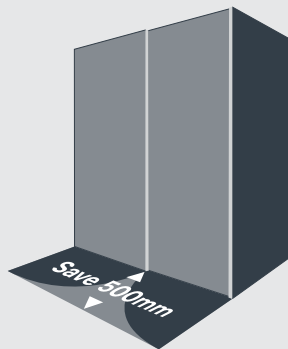

Did you know

If your opening space is too large, then you can build inwards to make your doors fit. See our fitting accessories for more info.

Space creating



Easy to install

Simply fit your sliding doors in a few hours, Locate and fasten your top & bottom tracks, then position your doors in-place.

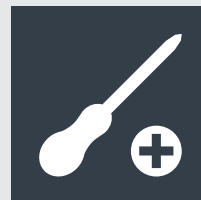

Screwdriver

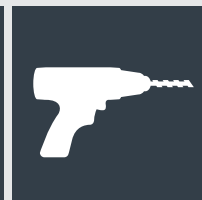

Drill



Pencil

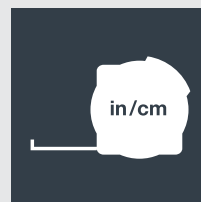

Tape measure

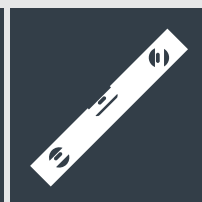

Spirit level



Create your sliding door solution in 3 easy steps

1

Plan your opening space

2

Choose your door range and interior storage

3

Select your door sizes (fixed size or custom size)

Choose your door design

Silver frame mirror & glass panel doors



Fixed sized doors

Our fixed sized doors are made to fit an opening height of 2260mm and are available across 9 different opening widths from 1195mm-3606mm. For sizing guide details and how to work out what trackset you need see page 6.

Don't forget to order your tracksets.

Custom sized doors

Our custom sized doors can be made to fit any opening between 1200-2480mm high and from 1200-4555mm wide. They come complete with a colour matched trackset.



Encased with a modern silver effect frame with a selection of glass colours to choose from, doors are available in 3 fixed door widths or can be custom made. Available as a single and 4 panel design.

Available designs:



Single Panel



4 Panel

Available finishes:

Glass & Mirror

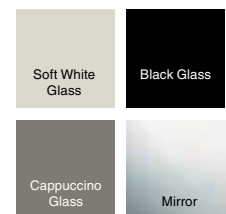

Note: The 4 panel door comes in 1 finish only

Wood effect frame mirror & panel doors



Fixed sized doors

Our fixed sized doors are made to fit an opening height of 2260mm and are available across 9 different opening widths from 1195mm-3606mm. For sizing guide details and how to work out what trackset you need see page 6.

Don't forget to order your tracksets.

Custom sized doors

Our custom sized doors can be made to fit any opening between 1200-2480mm high and from 1200-4555mm wide. They come complete with a colour matched trackset.



This collection offers 3 wood effect colour frame choices that encase either a full Mirror or matching Wood effect panel, these doors are available in 3 fixed door widths or can be custom made.

Available designs:



Single Panel

Available finishes:

Wood effects & Mirror

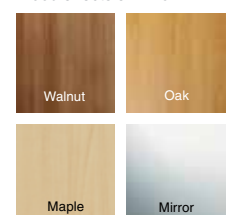

Wood effect frame 3 panel doors



Available in three wood effect finishes in either a Wideline or Fineline design. Choose your matching top and bottom panels and complete the look with a choice of three glass finishes or a mirror centre. The frame will be in the same wood effect as the top and bottom panels.

Available designs:

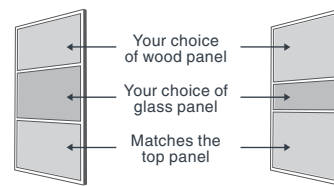

Available finishes:

Wood effects

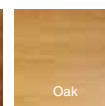
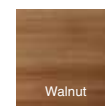

Glass & Mirror

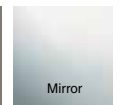
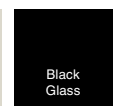

Fixed sized doors

Our fixed sized doors are made to fit an opening height of 2260mm and are available across 9 different opening widths from 1195mm-3606mm. For sizing guide details and how to work out what trackset you need see page 6.

Don't forget to order your tracksets.

Custom sized doors

Our custom sized doors can be made to fit any opening between 1200-2480mm high and from 1200-4555mm wide. They come complete with a colour matched trackset.

Project & designer fixed sized doors



Our Project & Designer doors are available in fixed sized doors only, with a selection of fixed widths with opening height of 2260mm. This range includes our traditional white frame mirror and panel doors (A, B & C) as well as a contemporary offering in silver effect frame encasing printed designer mirror doors (D, E & F).

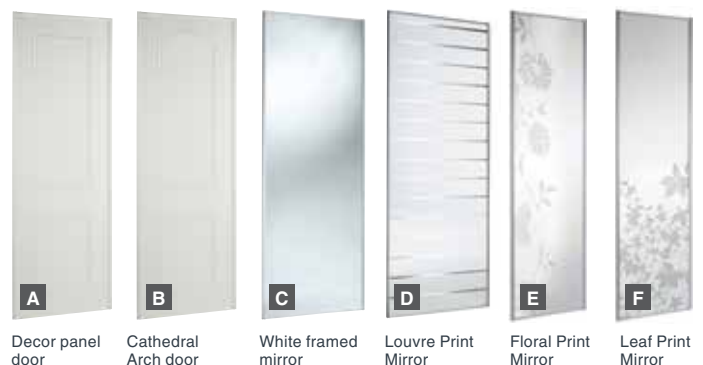

A Decor panel door

B Cathedral Arch door

C White framed mirror

D Louvre Print Mirror

E Floral Print Mirror

F Leaf Print Mirror

Modular storage solutions



The innovative Aura modular storage system offers a wide range of accessories making it ideal for getting the storage you actually need. The Aura storage system can adapt with your lifestyle, allowing you to reorganise your storage space adding accessories such as shoe racks and additional shelving.

Modular storage components and bundle options

<p>A Telescopic post Silver effect W 2110 - 2700mm 218489</p> <p>B Small single shelf W 550, D 330, H 25mm 218493 White</p> <p>C Large single shelf W 900, D 500, H 25mm 218494 White</p> <p>D Small two drawer kit W 550, D 500, H 350mm 218492 White</p> <p>E Large two drawer kit W 900, D 500, H 350mm 218491 White</p> <p>F Telescopic hanger bar rail Silver effect W 700 - 1300mm 218488</p> <p>G Fixed hanger bar rail Silver effect W 550 218497</p>	<p>H Trousers rack Silver effect W 900, D 500, H 25mm 218490</p> <p>I Double shoe rack Silver effect W 900mm 218495</p> <p>Shelf brackets Silver effect. Pack of 2 (Sold separately). 218487</p> <p>Drawer brackets Silver effect. Pack of 2 (Sold separately). 218496</p>	
--	--	--

Use our bundle options to kick start your ideal storage solution, or build your very own storage interior from scratch

Min to Max height 2100-2700mm; Min to Max width 610-3606mm.



Small interior W1300 - 1900mm

What's included

- Telescopic Post x2
- Telescopic Hanger Bar Rail x1
- Small Single Shelf x2
- Small Two Drawer Kit x1
- Shelf Brackets x2
- Drawer Brackets x1

Medium interior W2000 - 3200mm

What's included

- Telescopic Post x2
- Telescopic Hanger Bar Rail x2
- Small Single Shelf x2
- Small Two Drawer Kit x1
- Shelf Brackets x2
- Drawer Brackets x1

Large interior W2575 - 3606mm

What's included

- Telescopic Post x3
- Telescopic Hanger Bar Rail x2
- Small Single Shelf x4
- Small Two Drawer Kit x2
- Shelf Brackets x4
- Drawer Brackets x2

Also available in white are our Standard interior unit and Drawer pack

Standard interior unit*
H:2032mm x W:381-2835mm x D:365mm
207618

Drawer pack
Fits between 2 of the shelves.
(Sold separately).
207619

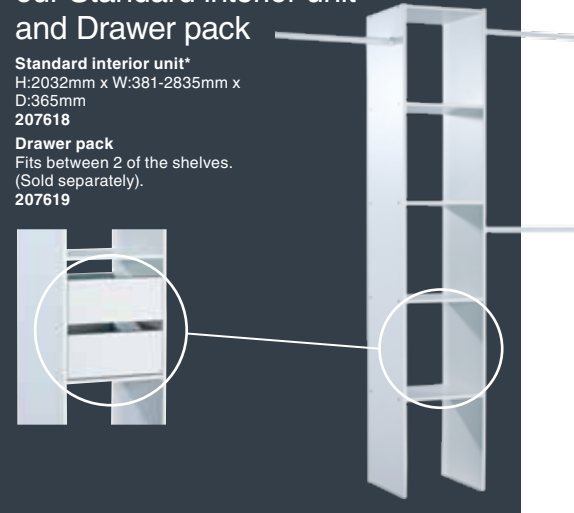

How to order your doors

A Measure your opening height & width

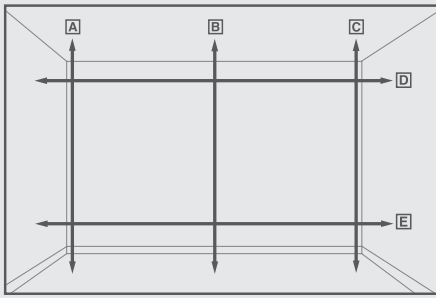

Opening space

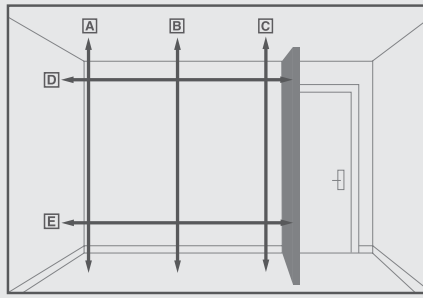

Building inwards

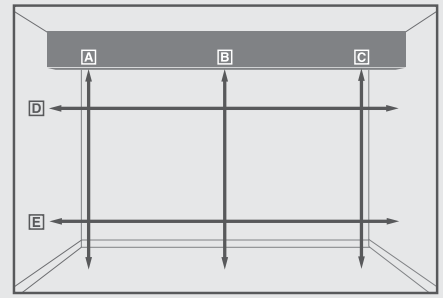

Building down

B Choose your door range and design



Silver Frame Mirror & Glass Panel Doors



Wood Effect Frame Mirror & Panel Doors



Wood effect frame 3 panel doors



Project & Designer Fixed Sized Doors

C Select between fixed and custom size doors

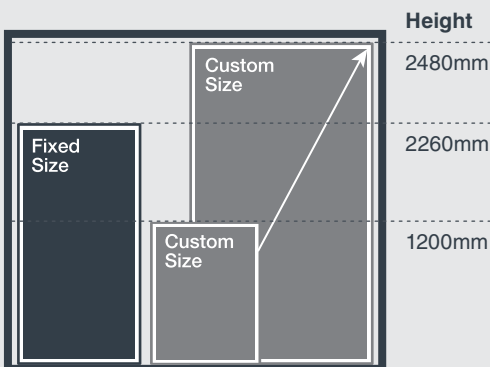

Fixed sized doors

- Trackset sold separately.
- Build or adjustment of your opening may be required.

Custom sized doors

- Colour matched trackset is included.
- Made to fit any opening space.
- Soft-close comes as standard on all custom doors over 650mm wide.

For fixed size doors

1. Calculate how many doors you need for your opening using our handy calculator. →
2. Select the range, design and size of the doors and trackset required using the product list found on page 8.

For custom size doors

1. To order custom size doors simply complete the order form on page 7 and then take to store who will finalise and process the order.

Calculate how many fixed sized doors you need...

	Ideal opening width	Door widths	Trackset length
2	1195mm	610mm	1803mm
	1499mm	762mm	1803mm
	1803mm	914mm	1803mm
3	1780mm	610mm	1803mm
	2236mm	762mm	2692mm
	2692mm	914mm	2692mm
4	2390mm	610mm	2692mm
	2998mm	762mm	3607mm
	3606mm	914mm	3607mm

Custom sliding doors - order form

Please complete this order form in block capitals and hand it in to our Store Team who will ensure that your products are ordered for you. You will be contacted by our supplier in a few days to arrange a delivery date.

1. What's your space?

Custom doors are made to fit the opening dimensions:

Height: Min 1200mm - Max 2480mm
Width: Min 1200mm - Max 4550mm

Measure your opening height and width at the five points indicated on the diagram to the right. This measurement is best taken approx 620mm from the back wall to allow for your storage system.

Please take into account any obstructions such as coving, skirting, radiators etc. Either remove these or build an unobstructed opening around them.

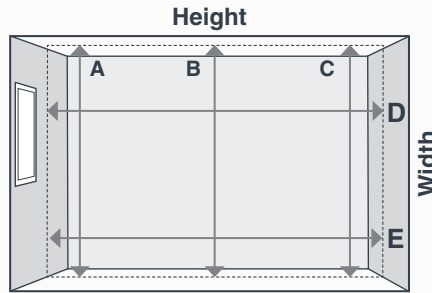

Our custom doors come with colour matched tracksets cut to fit into your opening width

A-C Opening Height

A: mm

B: mm

C: mm

D-E Opening Width

D: mm

E: mm

Note: Please ensure all measurements are stated in mm

2. Select how many doors you need

2 doors will fit openings from 1200 to 2375mm wide

Cross here

3 doors will fit openings from 1600 to 3550mm wide

Cross here

4 doors will fit openings from 2150 to 4555mm wide

Cross here

Note: Due to the amount of overlaps that may be required, the individual door width may vary slightly in relation to your calculated size.

Soft-close included on all doors wider than 650mm

3. Choose your preferred door range

To work out which door size of required (SKU), divide measurement E by number of doors required.
Note: Use 1 order form per room and you cannot mix door ranges to create one feature.

Custom size door ranges

Silver frame mirror & glass panel doors

Single panel Cross here

4 panel Cross here

Note: Single & 4 panel doors can be combined. The 4 panel door comes in 1 finish only.

Choose your finish

	Soft White Glass	Black Glass	Cappuccino Glass	Mirror
Write Qty Needed	Cross here <input type="checkbox"/>	Cross here <input type="checkbox"/>	Cross here <input type="checkbox"/>	Cross here <input type="checkbox"/>
Single Panel				
550-900mm wide sku 146340	Qty			
901-1200mm wide sku 146341	Qty			
4 Panel				
550-900mm wide sku 146342	Qty			
901-1200mm wide sku 146343	Qty			

Wood effect frame mirror & panel doors

Single panel Cross here

Note: Wood effect panel and mirror doors can be combined. If selecting mirror door only, then put a cross under your choice of wood effect frame.

Choose your finish

	Walnut	Oak	Maple	Mirror
Write Qty Needed	Cross here <input type="checkbox"/>	Cross here <input type="checkbox"/>	Cross here <input type="checkbox"/>	Cross here <input type="checkbox"/>
Single Panel				
550-900mm wide sku 146350	Qty			
901-1200mm wide sku 146351	Qty			

Wood effect frame 3 panel doors

3 panel Finline Cross here

3 panel Wideline Cross here

Note: Select either Finline or Wideline.

Choose your finish

Top & bottom panels	Walnut	Oak	White	
Write Qty Needed	Cross here <input type="checkbox"/>	Cross here <input type="checkbox"/>	Cross here <input type="checkbox"/>	
550-900mm wide sku 146412	Qty			
901-1200mm wide sku 146413	Qty			
Middle panel	Soft White Glass	Black Glass	Cappuccino Glass	Mirror
Cross here <input type="checkbox"/>	Cross here <input type="checkbox"/>	Cross here <input type="checkbox"/>	Cross here <input type="checkbox"/>	

Note: The colour and style options you choose will apply to all the doors in your order, for this range only. Top and bottom panels will be the same finish.

Customer details

Name:

Address:

Postcode: Email address:

Contact tel: Customer order date:

Note: Products can not be returned or exchanged unless damaged or faulty. This does not effect your statutory rights

Customer signature: Date:

Terms and Conditions: I understand these products will be supplied according to the information I have provided and I accept responsibility for the accuracy of this information. Please do not arrange for any contractors or 'workmen' to be present, or remove old structures and make holes in any walls until you have received and checked your goods. Wickes cannot be held responsible for any cost that may be incurred due to a delivery that is delayed for reasons beyond our control; delivery must be accepted and signed for on receipt. All prices include delivery. Delivery will be carried out by our supplier on our behalf and we shall pass them your details for this purpose.

Accessories & tracksets

Product List

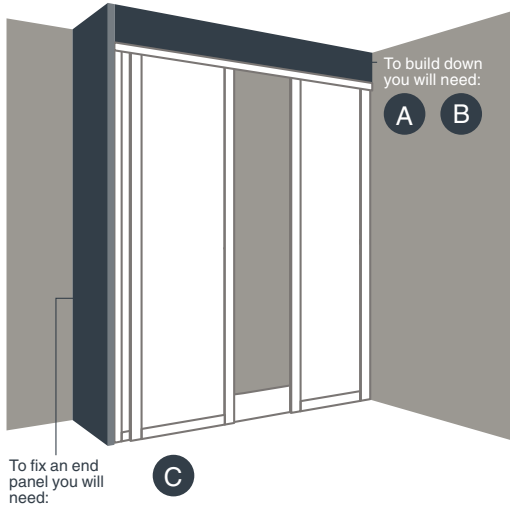

Our accessories can reduce your opening height by up to 475mm.



Spacer Blocks (pk of 12)
Reduces gaps by up to 120mm
218444

Opening Height Reducer
Reduces gaps between 127-457mm
207617

Fixing Blocks (pk of 10)
Fits end panels to existing walls.
218445

Don't forget your tracksets

Lengths up to 1803mm
207650 – Silver
207608* – White

Lengths up to 2692mm
207651 – Silver
207609* – White

Lengths up to 3606mm
207652 – Silver
207610* – White

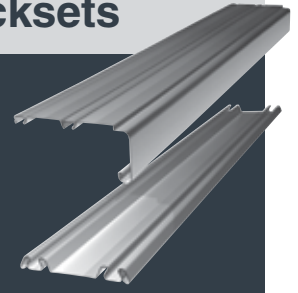

With our fixed size sliding doors you will need to buy the tracksets separately. Available in 3 different lengths, in both silver and white finishes to match the door frames.

Sliding Wardrobe Doors

Silver Frame Mirror & Glass Panel Doors

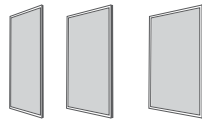

Single Panel	Fixed Sizes	610mm wide	762mm wide	914mm wide
	Soft White Glass	146291	146292	146293
	Black Glass	146294	146295	146296
	Cappuccino Glass	146297	146308	146309
	Mirror Glass	207629	218449	218450
	Custom Sizes	550-900mm wide	901-1200mm wide	
		146340	146341	
4 Panel	Fixed Sizes	610mm wide	762mm wide	914mm wide
	Soft White Glass	146316	146317	146324
	Black Glass	146325	146332	146333
	Cappuccino Glass	146334	146335	146336
	Mirror Glass	146337	146338	146339
	Custom Sizes	550-900mm wide	901-1200mm wide	
		146342	146343	

Wood Effect Frame Mirror & Panel Doors

Single Panel	Fixed Sizes	610mm wide	762mm wide	914mm wide
	Walnut Frame Mirror	218455	218457	218459
	Walnut Frame & Panel	218461	218463	218465
	Oak Frame Mirror	218456	218458	218460
	Oak Frame & Panel	218462	218464	218466
	Maple Frame Mirror	146344	146345	146346
	Maple Frame & Panel	146347	146348	146349
	Custom Sizes	550-900mm wide	901-1200mm wide	
		146350	146351	

Project & Designer Fixed Sized Doors

Fixed Sizes	610mm wide	762mm wide	914mm wide
Decor Panel Door		218447	218448
Cathedral Arch Door*		207602	207603
White Frame Mirror*	218446	207600	207601
Louvre		218453	218454
Leaf Print	218452		
Floral Print	218451		

Wood effect frame 3 panel doors

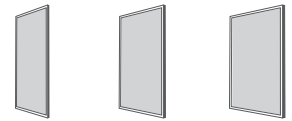

Wideline	Fixed Sizes	610mm wide	762mm wide	914mm wide	
	Walnut / Soft White Glass	187535	146352	218471	
	Walnut / Black Glass	146353	146354	146355	
	Walnut / Cappuccino Glass	146356	146357	146358	
	Walnut / Mirror	146359	146360	146361	
	White / Soft White Glass	187556	146372	218479	
	White / Black Glass	146373	146374	146375	
	White / Cappuccino Glass	146376	146377	146378	
	White / Mirror	146379	146380	146381	
	Oak / Soft White Glass	187536	146362	218481	
	Oak / Black Glass	146363	146364	146365	
	Oak / Cappuccino Glass	146366	146367	146368	
	Oak / Mirror	146369	146370	146371	
	Custom Sizes	550-900mm wide	901-1200mm wide		
			146412	146413	
	Fineline	Fixed Sizes	610mm wide	762mm wide	914mm wide
	Walnut / Soft White Glass	218477	146382	218478	
	Walnut / Black Glass	146383	146384	146385	
	Walnut / Cappuccino Glass	146386	146387	146388	
	Walnut / Mirror	146389	146390	146391	
	White / Soft White Glass	218467	146402	218473	
	White / Black Glass	146403	146404	146405	
	White / Cappuccino Glass	146406	146407	146408	
	White / Mirror	146409	146410	146411	
	Oak / Soft White Glass	218469	146392	218475	
	Oak / Black Glass	146393	146394	146395	
	Oak / Cappuccino Glass	146396	146397	146398	
	Oak / Mirror	146399	146400	146401	
	Custom Sizes	550-900mm wide	901-1200mm wide		
			146412	146413	

Our custom size doors come complete with a colour matched trackset*
*Selected products are available in store to take away or on a next day delivery. Ask in store for details.

For further details visit wikes.co.uk